

# TB400 PLUS FENCE BOPLAN SAFETY BARRIER SPECIFICATION SHEET

Boplan reference: TF4000

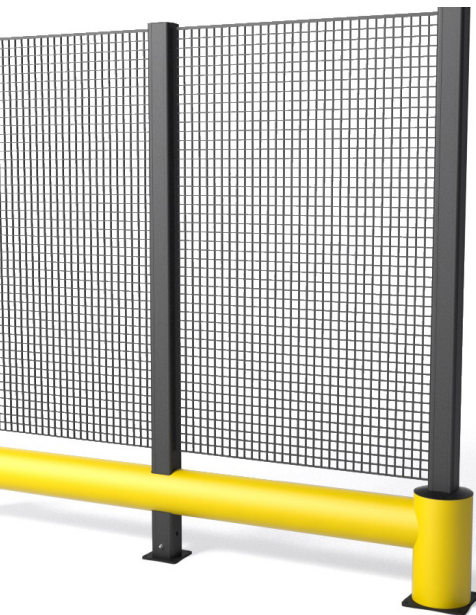





Revision: 11 October 2021 3:39 PM



## PRODUCT SPECIFICATIONS

APPLICATION	
Environment	TB400 Plus Fence provides an effective crash protection with machine guard fencing.
Compliance	The narrow mesh size allows a close safety distance of 200mm towards the danger. (According machine directive 2006/42/EC)
Impact performance at 90° (in JOULE)	POST: 16100 Joule (Eq. to 5ton - 9.1 km/h)
	RAIL: 20100 Joule (Eq. to 5ton - 10.2 km/h)
MATERIAL	
Posts	Polyolefin - UV resistant - Fire class E <sup>+</sup> - Non conductive - Impervious to most chemicals**
Mesh	Glass fiber reinforced composite
Caps	SEBS rubber
STANDARD COLORS	
End post / Mid post / Tubes	Yellow
Mesh	Black
BASEPLATES	
	Steel
Material	Steel 37
Coating	Lacquered
Color	High gloss black

\*Classification according to EN 13501-1:2007 +A1:2009 - Fire classification of construction products and building elements.  
\*\*Ask your local sales office for resistance to specific chemicals.

		FIXATIONS	
		ZC (Zinc coated)	SS (Stainless steel)
STANDARD	Wedge anchor	 M12 x 120mm	M12 x 120mm
	Wedge anchor Countersunk	 Not available	Not available
	Anchor rod (Chemical)	 M12 x 120mm + Chemical resin	M12 x 120mm + Chemical resin
ALTERNATIVES	Concrete screw	 Ø12mm x 100mm	Ø10mm x 100mm
	Asphalt anchor	 Bolt M10 x 40mm + Screw Ø16mm	Not available
	Spit anchor	 Bolt M12 x 100mm + Plug Ø20mm	Not available

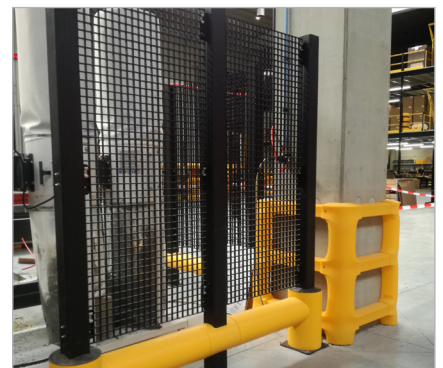
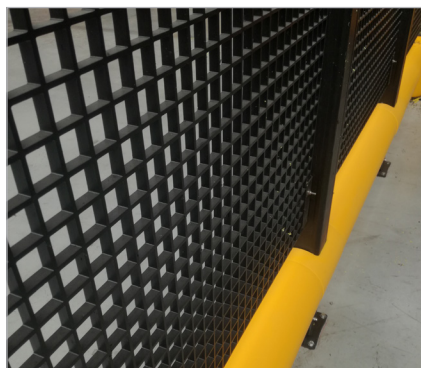

**FEATURES AND FUNCTIONALITY**

SIZE	
Height end posts	2300 mm
Height mid post	2300 mm
Profile section tubes	Ø200 mm (11 mm thick)
Mesh	1220 mm x 1800 mm (13mm thick) Mesh inner dimension 33 mm x 33 mm
Profile section end posts	Outer tube: Ø250 mm (11 mm thick) Inner profile: 112 mm x 112 mm (10 mm thick)
Profile section mid posts	Profile: 112 mm x 112 mm (10 mm thick)
Standard rail length	1350 mm (center - center dimension) Other sizes: 850 mm - 1349 mm (center - center dimension)
Baseplate	End Post: 275 mm x 275 mm x 10 mm Mid Post: 180 mm x 180 mm x 10 mm

REQUIREMENTS	
Concrete quality	minimum C25/30
Concrete floor plate thickness (mm)	minimum 150 mm
Concrete slab dimension around posts (mm)	600 (h) x 600 (w) x 300 (d)
Operational temperature	-10°C up to +40°C
Water and humidity	<b>Steel (standard):</b> dry indoor use only. <b>Zinc coated:</b> outdoor use in most environments. <b>Stainless Steel:</b> outdoor use or frequent exposure to water and humidity.

COMPLIANCE MESH	
Machine directive	The narrow mesh size allows a close safety distance of 200mm towards the danger. (According machine directive 2006/42/EC)
Impact resistance of mesh	Static point load of 450 N gives a maximum deflection of 15.7 mm.

## IMPACT LABEL FOR SAFETY BARRIERS

**BOPLAN TB400 PLUS FENCE**

**IMPACT RATING**

	45°	90° <small>PAS 13:2017 compliant</small>
E80 < 80 kJ		
E60 < 60 kJ		
E50 < 50 kJ		
E40 < 40 kJ		
E35 < 35 kJ		
E30 < 30 kJ	<b>28,4 kJ</b>	
E25 < 25 kJ		<b>20,1 kJ</b>
E20 < 20 kJ		
E15 < 15 kJ		
E10 < 10 kJ		
E5 < 5,0 kJ		
E2 < 2,5 kJ		

**TEST CONDITIONS**

TEMPERATURE: 20°C  
IMPACT HEIGHT: 300 mm  
IMPACT ANGLE: 90°  
TEST FLOOR: CONCRETE C25/30 - 160 mm  
MANUFACTURER ANCHOR PULL OUT: 7,9 kN

**TEST VEHICLE**

WEIGHT: 2300 KG  
TYPE: COMMERCIAL FORK LIFT  
SIZE (L x W x h): 1890 x 1020 x 1970 mm  
CONTACT AREA: STEEL BUMPER WIDTH: 600 mm

**ACCREDITED TEST LABORATORY**

620 Route des Fromentaux  
01500 Saint-Maurice-de-Rémens  
01360 Bègnieux  
France

**SUCCESS CRITERIA** VEHICLE STOPPED - ASI (ACCELERATION SEVERITY INDEX) < 0.5

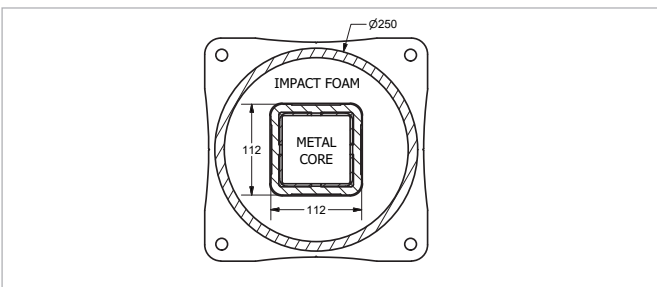
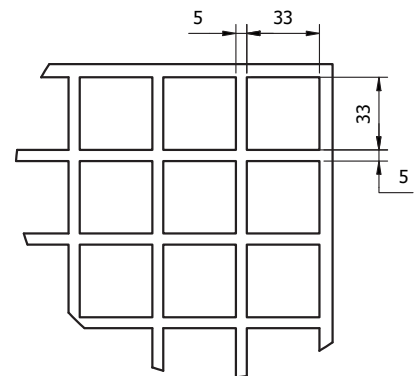

**REFERENCE LIST - TB400 PLUS FENCE**

POSTS		
End post - YE	TF4000-0001-EPYE	
End Corner post - YE - 90° - Up	TF4000-0001-CPUYE	
End Corner post - YE - 90° - Down	TF4000-0001-CPDYE	
Mid post - YE	TF4000-0001-MPYE	

CURVES		
Conn.tube Ø250mm - 90° Curve 350mm - YE	TF4000-0350-C259YE	

RAIL SETS			
	Tube length (A)	CC length (B)	REFERENCE
Standard rail	650 mm	900 mm	TF4000-0650-0900YE
Standard rail	800 mm	1050 mm	TF4000-0800-1050YE
Standard rail	950 mm	1200 mm	TF4000-0950-1200YE
Standard rail	1100 mm	1350 mm	TF4000-1100-1350YE

